

STUDIO•M

SM961910

Please consult your electrician for hanging fixture and wiring.

Please consult your electrician for hanging fixture and wiring.

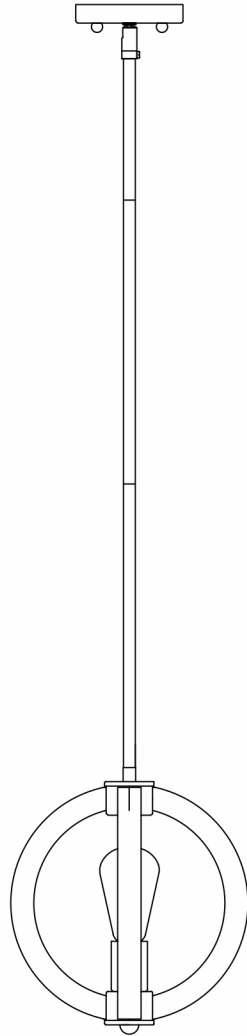

Bulb(not included): 1 Edison-style bulbs recommended

STUDIO•M

SM961910

Please consult your electrician for hanging fixture and wiring.

IMPORTANT: Turn off the power at the main fuse or circuit breaker box before starting installation

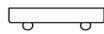

(A) Canopy



(B) Stem

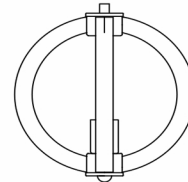

(C) Fixture

Locate all hardware & components before discarding packaging

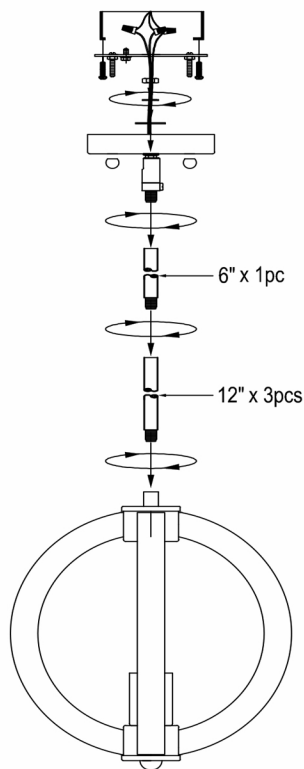

1.)

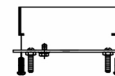

Step.1: Remove mounting bracket from fixture and install to electrical box

2.)

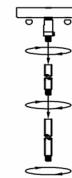

Step.2: Run wire through stems (B) and combine stem lengths to meet desired mounting height.

3.)

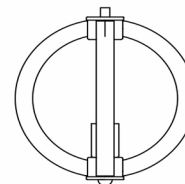

Step.3: Wire fixture to wires in outlet box. Copper/Green wire is for Ground.

4.)

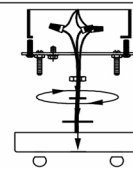

Step.4: Install fixture to bracket and tighten screws at the ends of the canopy (A) to secure.

Cleaning & Care:

Clean with soft cloth and a mild detergent. Do not use abrasive cleaner.