

# STUDIO • M

**Item/Model Number:** SM23819BCPN  
Lillet 10-Light LED Linear Pendant

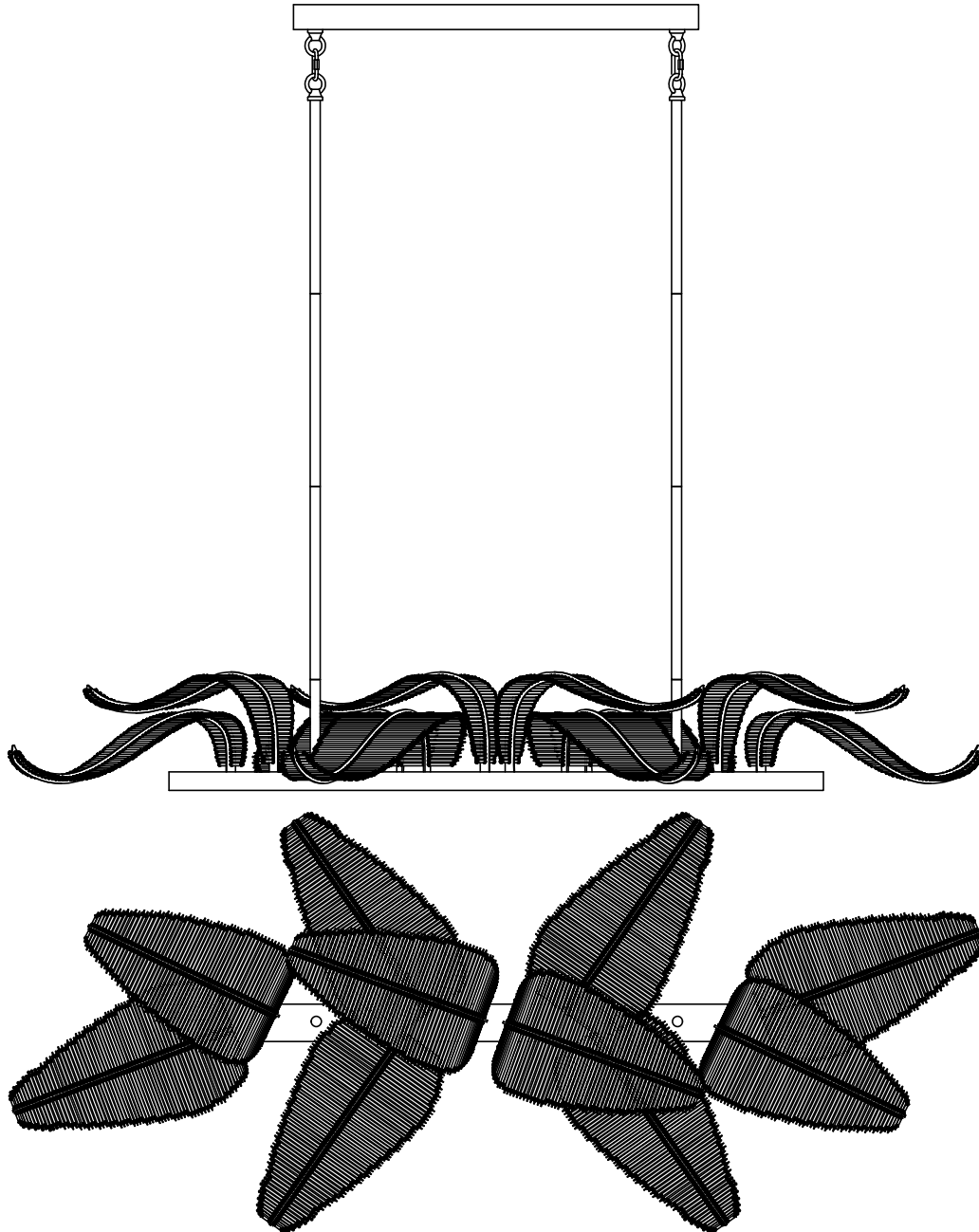









**Lamping | Ampoule: 10 x LED 5W (Included)**

Please consult a qualified electrician prior to install

Veuillez consulter un électricien qualifié pour suspendre le luminaire et le Câblage.

**Made in China | Fabrique en Chine | Hecho en China**

## LED LOW-VOLTAGE INSTRUCTIONS

| English <b>Before Getting Started</b>  | Français <b>Avant de Commencer</b>   | Español <b>Antes de Comenzar</b>  |
|--|--|---|
| Read the instructions carefully prior to assembling the product.   | Lire attentivement les instructions avant d'assembler le produit.  | Lea atentamente las instrucciones antes de ensamblar el producto.   |
| When you open the package with a sharp tool like a box knife, be careful not to damage the components inside.  | Lorsque vous ouvrez le paquet avec un outil pointu comme un couteau de coupe, veillez à ne pas endommager les composants à l'intérieur.  | Cuando abra el paquete con una herramienta afilada como un cuchillo de corte, tenga cuidado de no dañar los componentes dentro.   |
| Carefully remove all packaging materials and retain for future use.  | Retirez soigneusement tous les matériaux d'emballage et conservez-les pour un usage ultérieur.   | Retire con cuidado todos los materiales de embalaje y consérvelos para usarlos en el futuro.  |
| Keep all hardware parts and packaging out of reach of children.  | Conservez toutes les pièces matérielles et les emballages hors de portée des petits enfants.   | Mantenga todas las piezas y embalajes de hardware fuera del alcance de los niños pequeños.  |
| Choose a clean, level, spacious assembly area. Avoid hard surfaces that may damage the product.  | Choisissez une zone d'assemblage propre, de niveau et spacieuse. Évitez les surfaces dures qui pourraient endommager le produit.   | Elija una zona de ensamblaje limpia, nivelada y espaciosa. Evite superficies duras que puedan dañar el producto.  |
| Ensure that you have all required contents for complete assembly.  | Assurez-vous que vous avez tous les contenus requis pour l'assemblage complet.   | Asegúrese de que tiene todos los contenidos necesarios para el ensamblaje completo.   |
| Take care when lifting. Assemble the product in close proximity to where you intend to install it.   | Prenez soin de soulever. Assemblez le produit à proximité de l'endroit où vous comptez positionner l'élément.  | Tenga cuidado al levantar. Ensamble el producto cerca de donde tiene la intención de posicionar el artículo.  |
| Do not over tighten the screws and bolts as this may damage the threads.   | Ne serrez pas trop les vis et les boulons car cela pourrait endommager les filets.   | No apriete excesivamente los tornillos y pernos, ya que esto puede dañar los hilos.   |
| Do not let children play with this product.  | Ne laissez pas les enfants jouer avec ce produit.  | No permita que los niños jueguen con este producto.   |
|  <b>Risk of suffocation!</b><br>Keep packaging materials away from children.   |  <b>Risque asphyxiel!</b><br>Tenez tous les matériaux emballage à l'écart des enfants   |  <b>Riesgo de sofocación!</b><br>Mantenga los materiales de emb/alaje lejos de los niños.                                  |
| <b>Lamp Care Instructions</b>  | <b>Entretien de la Lampe</b>   | <b>Instrucciones de Lámparas</b>  |
| Carefully read through the instruction sheet before assembly and using the product.  | Avant de procéder à l'assemblage et à l'utilisation de la lampe, lisez attentivement le mode d'emploi.   | Lea cuidadosamente la hoja de instrucciones (si fue proporcionada) antes de armar y utilizar la lámpara.  |
|  <b>Caution there is a risk of shock!</b><br>Disconnect from power source before assembling or cleaning.                               |  <b>Pour éviter tout risque d'électrocution, débranchez la lampe de la prise électrique avant de procéder à l'assemblage ou au nettoyage de la lampe.</b> |  <b>Peligro por descarga eléctrica.</b> Desconecte la lámpara de la fuente de electricidad antes de armarla o limpiarla. |
| Switch off, unplug and allow bulb to cool before replacing bulb or cleaning.   | Avant de remplacer ou de nettoyer l'ampoule, éteignez et débranchez la lampe.  | Apáguela, desenchúfela y deje que la bombilla se enfríe antes de reemplazarla o limpiarla.  |
| Only <b>use the recommended</b> bulb type and do not exceed the maximum wattage as it could cause fire.  | Afin d'éviter tout risque de feu, utilisez le type et la puissance d'ampoule recommandés.  | Solo utilice el tipo de bombilla recomendado y no exceda la potencia eléctrica máxima ya que puede causar un incendio.  |
| Check the product cord to be sure is free torn or frayed.  | Ne branchez pas la lampe si son cordon d'alimentation est déchiré ou effiloché   | No conecte la lámpara si el cable eléctrico está dañado o deshilachado.   |
|  <b>WARNING:</b> Wires must be connected to low voltage driver and should not be connected directly to live wire or a short may occur. |  <b>AVERTISSEMENT :</b> Les fils doivent être connectés au conducteur et ne doivent pas être connectés directement aux fils sous tension                  |  <b>ADVERTENCIA:</b> Los cables deben estar conectados al controlador y no deben conectarse directamente al cable activo |
| <b>Cleaning &amp; Maintenance</b>  | <b>Nettoyage et Maintenance</b>  | <b>Limpieza y Mantenimiento</b>   |
| On polished finishes, often using talc powder can reduce the appearance of fingerprints and other smudges.   | Sur les finitions polies, souvent en utilisant la poudre de talc réduit l'apparence des empreintes digitales et d'autres taches.   | En acabados pulidos, a menudo usando polvo de talco reduce la aparición de huellas dactilares y otras manchas.  |
| For respective shade surfaces, use the appropriate cleansers, i.e. glass cleaner, stone polish, & wood polish.   | Pour les surfaces d'ombrage respectives, utilisez les nettoyants appropriés, c'est-à-dire le nettoyant pour vitres, vernis à pierre et le vernis à bois.   | Para las respectivas superficies de sombra, utilice los limpiadores apropiados, es decir, limpiador de vidrio, esmalte acrílico y pulido de madera.   |
| Clean with soft cloth and a mild detergent. Do not use abrasive or harsh cleaners.   | Nettoyer avec un chiffon doux et un détergent doux. N'utilisez pas de nettoyant abrasif.   | Utilice un trapo limpio, suave y seco que no raye ni manche la superficie cuando quite el polvo.  |
| Periodically (every 90-180 days) make sure that the screws are fully tightened.  | Périodiquement (tous les 90-180 jours), assurez-vous que les vis sont bien serrées.  | Periódicamente (cada 90-180 días) asegúrese de que los tornillos estén bien apretados.  |
| Prolonged exposure to heat sources may cause glazing, melting and scorching, or even cause color to fade.  | Si le tissu subit une exposition prolongée aux sources de chaleur, il pourrait commencer à reluire, à roussir, à s'estomper ou même à se décolorer.  | La exposición prolongada a las fuentes de calor causa cristalización, derretimiento, quemadura y decoloración del tapizado.   |

English

## PARTS

Francais

## PIÈCES





Espanol

## PARTS

Before getting started, ensure the package contains the following components:

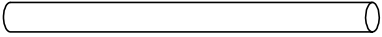
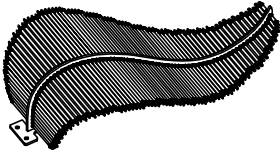
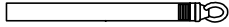
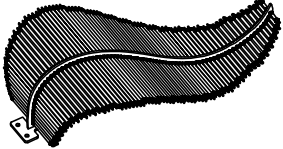
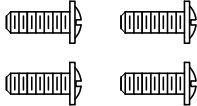
Antes de comenzar, asegurese de que el paquete contenga los siguientes componentes:

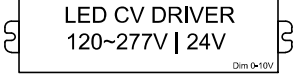
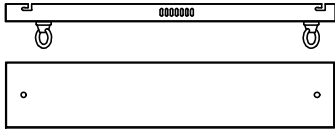
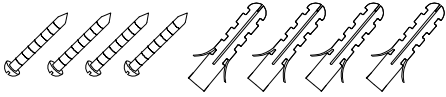
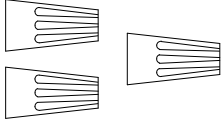
Avant de commencer, assurez-vous qu le paquet contient les composants suivants:

|   |  |     |   |  |    |
|---|--|-----|---|--|----|
| A |  <p>SCRA23819BCPN-A</p>             | X6  | I |  <p>SSTR06212PN-LX</p>   | X6 |
| B |  <p>SCRA23819BCPN-B</p>             | X2  | J |  <p>Ø0.6*L6.8"</p>  | X2 |
| C |  <p>SCRA23819BCPN-C</p>             | X2  | K |  <p>M4*L0.47"</p>   | X4 |
| D |                                   | X1  | L | <p>PVD54-C225V24-UNV4-HE-P</p>  <p>LED CV DRIVER<br/>120~277V   24V<br/>Dim 0-10V</p> <p>L4.7"*W2.4"*H1.0"</p> | X1 |
| E |                                   | X1  |   |  |    |
| F |  <p>M5*L1.57"      Ø0.3*L1.5"</p> | X12 |   |  |    |
| G |                                   | X3  |   |  |    |
| H |                                   | X1  |   |  |    |

This fixture is equipped with an LED driver, please refer to **Wiring Diagram** for more details.

Ce luminaire est équipé d'un pilote a LED, veuillez vous référer au **Schéma De Câblage** pour plus de détails.

Este accesorio está equipado con un controlador LED, por favor consulte el Diagrama De Cableado para obtener más detalles.

1.

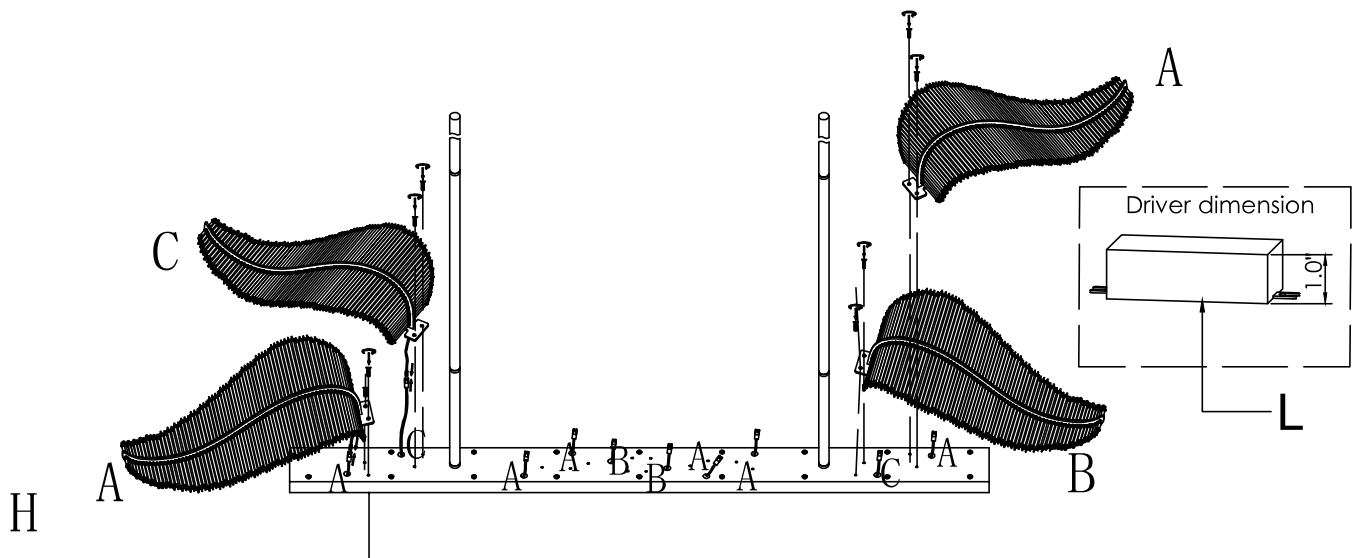
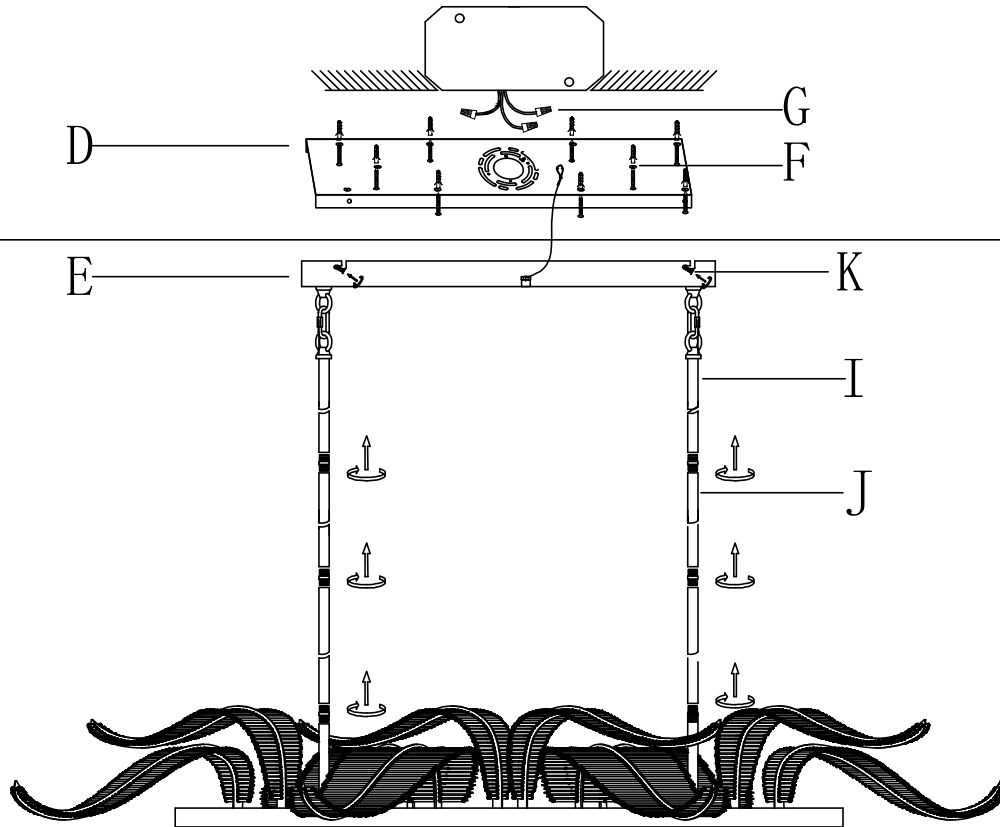

**Warning: Please Install  
lampshade code A first.**

Model: SM23819BCPN  
Crystal Diagram

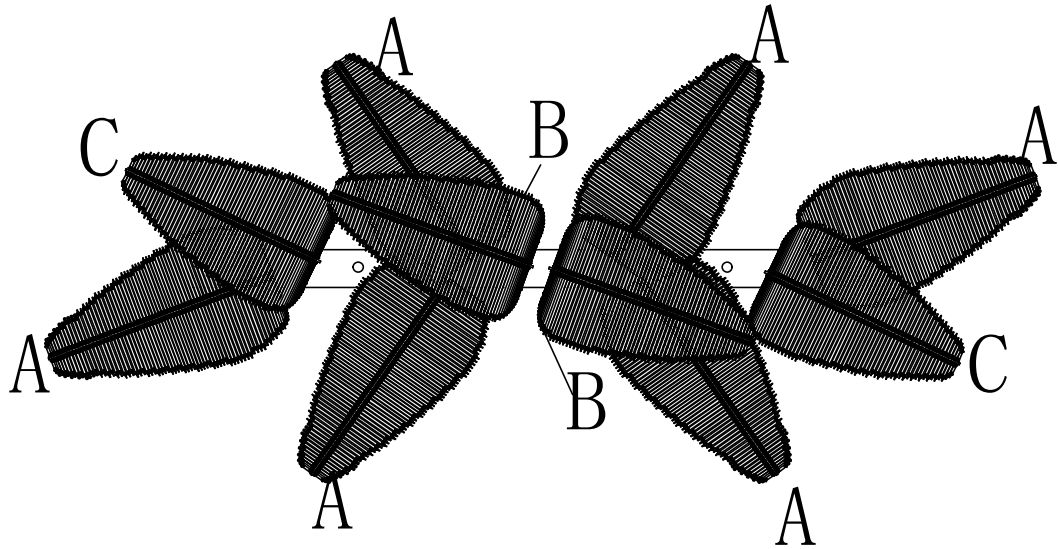

| Code | Studio M#       | Q'ty | Size               |
|------|-----------------|------|--------------------|
| A    | SCRA23819BCPN-A | 6    | L15"*W8.5"*H4.7"   |
| B    | SCRA23819BCPN-B | 2    | L15"*W8.5"*H6.6"   |
| C    | SCRA23819BCPN-C | 2    | L13.8"*W8.5"*H4.7" |

**ITEM/MODEL:** SM23819BCPN

MUST be installed by an experienced professional  
CRITICAL KNOWLEDGE of electronic lighting systems required

IMPROPER WIRING and/or INCORRECT DIMMER use can cause CATASTROPHIC DAMAGE!

THIS FIXTURE MUST BE INSTALLED with a COMPATIBLE DIMMER SWITCH

DO **NOT** CUT FACTORY-MADE CONNECTIONS.

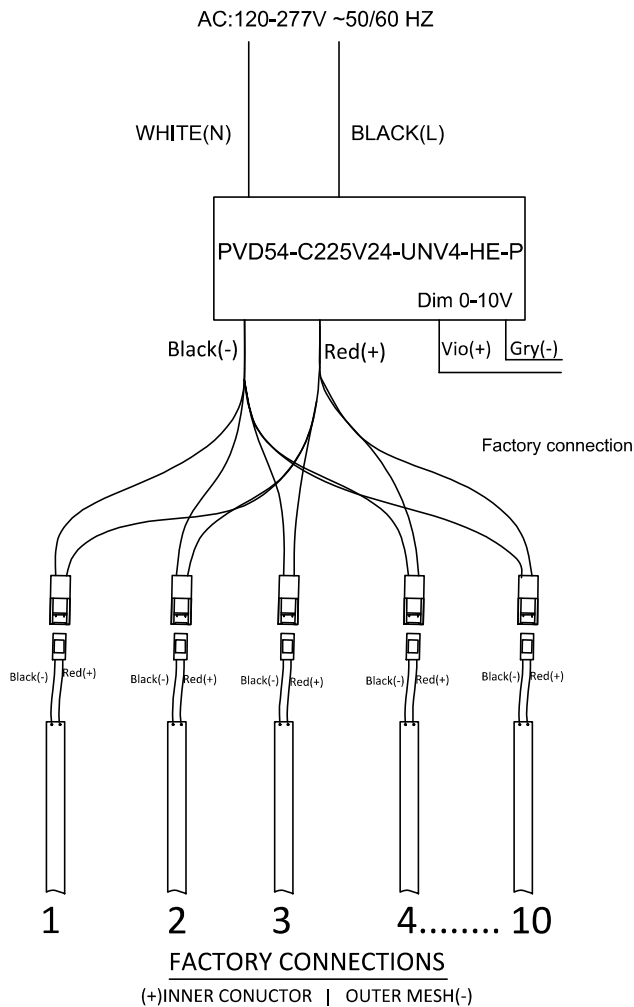

### LED DRIVER DIAGRAM

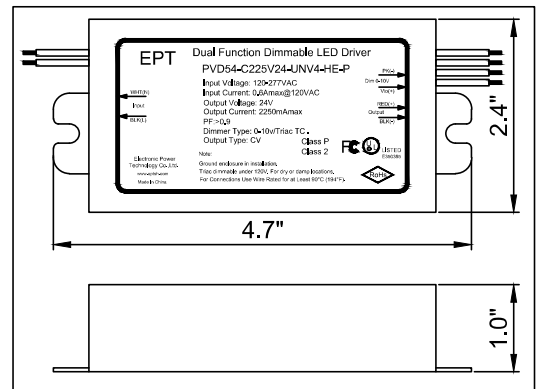

SCHEMATIC  
FOR GENERAL  
REFERENCE ONLY

#### VERIFIED LIST OF TESTED DIMMERS

Lutron Diva DVCL-153P  
Lutron Diva DVELV-300P  
Lutron Skylark CTCL-153P  
DEAKO-Smart Dimmer  
DEAKO-Simple Dimmer  
LEVITON 6672-L  
LEVITON 6674  
LEVITON DSL06

#### GENERAL COMPATIBILITY

**TRIAC / FORWARD PHASE**  
**ELV / REVERSE PHASE**  
**ONLY at 120VAC**  
**0-10VLOW VOLTAGE**  
**Wor at 120-277VAC**

Due to inrush current,wattage should  
not exceed 150W on a 600W dimmer

#### IMPORTANT!

If the control is not paired properly to LED  
fixtures,irreparable damage may occur.

If the dimmer you are using is not listed here,  
consult a lighting professional or visit:  
<https://www.studiomlighting.com/>

**MUST be installed by an exprienced professional**  
**CRITICAL KNOWLEDGE of electronic lighting systems required**