





PRODUCT DESCRIPTION

Drum shades in a variety of fabrics and materials are a core lighting offering. Flush mounts, pendants, and ADA sconces are available in options of linen, organza, grasscloth, and sound absorbing grey felt shades. An internal acrylic diffuser, illuminated by an evenly dispersed powerful LED light source, directs light downward and produces an ambient glow inside the outer shade. This lens features a crisp and tidy twist-lock mechanism that eliminates any visible hardware. Whether it is put in a residential or commercial context, this collection meets the necessary application needs while adding style to the space.

FINISHES OPTION

-  Oil Rubbed Bronze (OI)
-  Satin Nickel (SN)

MATERIAL

Steel, Acrylic, Fabric

RATINGS

cETLus
Dry Location



ADDITIONAL

ADJUSTABLE
SLOPE: 120
RATED LIFE 35000 Hours
OPERATING TEMPERATURE:
-20°C (-4°F), 40°C (104°F)

PHOTOMETRIC: Report Found Online

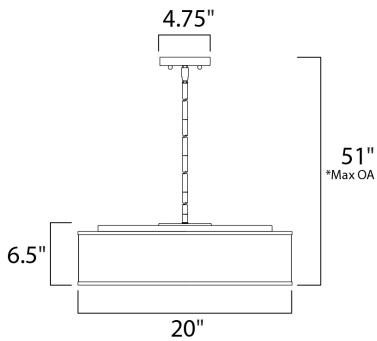

MEASUREMENTS

DIMENSION : 20" L x 20" W x 6.5" H
 MAX OAH : 51" OAH
 CANOPY : 4.75" W x 0.75" H x 4.75" L
 HANGING WEIGHT : 8.84 lb

LAMPING

INPUT VOLTAGE : 120V
 LUMENS : 2,275 Rated
 BULB : 6.5W LED PCB Integrated , 32W Total
 BULB INCLUDED : (Integrated)
 DIMMABLE : Electronic Low Voltage (ELV)
 CRI : 90+ CRI
 COLOR_TEMP : 3000K

*max overall height

Always consult a qualified electrician before installing any lighting product.



Modifications or Customizations: Please email contract@studiomlighting.com
Sample Request: Please email order@studiomlight.com with subject line "Sample Order_ [Project Name] / [Specifier/Designer]"
 All samples are subject to Studio M approval and must show proof of project and/or explanation.

| | |
|-----------|-----------|
| Job Name: | Job Type: |
| Quantity: | Comments: |